



STACK RAY 12" STEM HUNG PENDANT LIGHT

STGX471



FEATURES + BENEFITS

- Metal RLM shades are spun from heavy duty aluminum.
- Polyester powder coat finish provides color retention and scratch resistance.
- White powder coat shade interior for maximum light output.
- Dimmable with a dimmable bulb and compatible dimmer (not included).
- Adjustable height up to 48"; 1-6", 2-12", 1-18" stem lengths included.
- UL Listed for Wet Location.
- Warranty: Limited 1 Year.
- Made in USA.

SPECIFICATIONS

Product Dimensions:

Width 12", Shade Height 12", Overall Height 60", Canopy Dia. 4 5/8"

Lamping:

100W Medium Base per socket

Options:

- Finish: 16-Cream, 17-Ivory, 19-Terracotta, 20-Mauve, 21-Bright Yellow, 22-Fern Green, 40-Slate Gray, 41-Black, 42-Forest Green, 44-White Gloss, 48-Sea Green, 50-Navy, 51-Architectural Bronze, 54-Light Blue, 55-Barn Red
- Integrated LED: L12-10W, 800 Lumen, 95CRI, Adjustable CCT.
- Glass Globe: G15-6" White Opal Glass Globe

Shipping:

At Montclair Light Works we proudly manufacture, assemble, and ship your lamp within 3 weeks from our factory in Montclair CA.

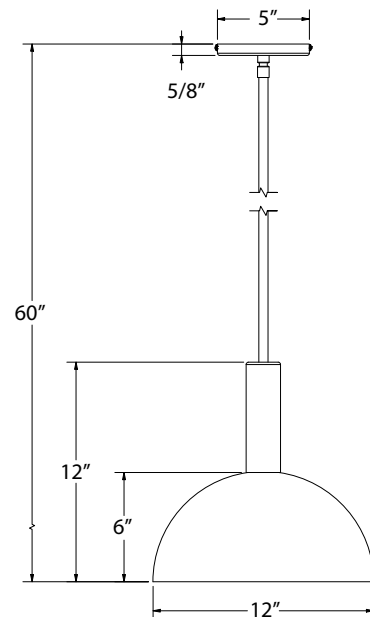

JOB/LOCATION

QUANTITY

DATE

NOTES